



Approved by:
Checked by:
Issued by:

SPECIFICATION

PRODUCT: SAW FILTER

MODEL: HF738901D (K7257D) SIP5D

HOPE MICROELECTRONICS CO., LIMITED

1. Construction

1.1 Dimension and materials

Type : F738901D

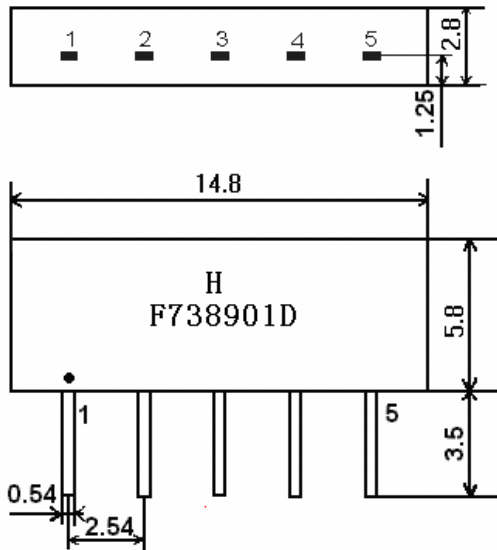

Unit : mm

1. Input
2. Switching Input
3. Chip carrier - ground
4. Output
5. Output

1.2. Circuit construction, measurement circuit

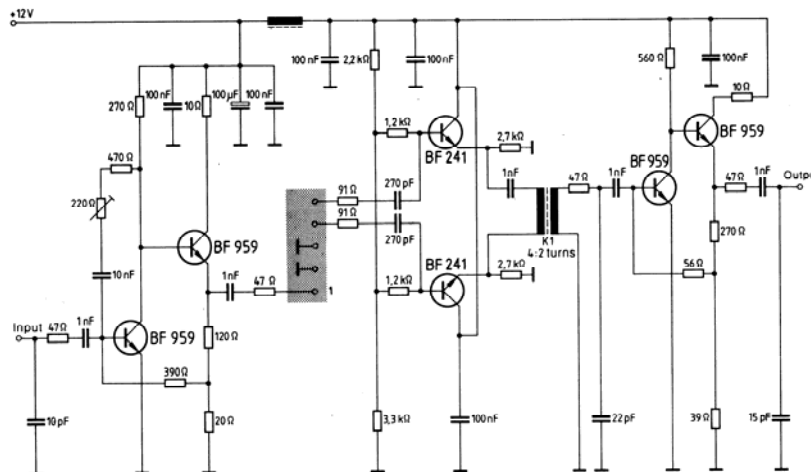

Test circuit for SIP-5 filter

Input impedance of the symmetrical post-amplifier: 2 kΩ in parallel with 3 pF

2.Characteristics

Standard atmospheric conditions

Unless otherwise specified , the standard rang of atmospheric conditions for making measurements and tests is as follows;

- Ambient temperature : 15°C to 35°C
- Relative humidity : 25% to 85%
- Air pressure : 86kPa to 106kPa

Operating temperature rang

Operating temperature rang is the rang of ambient temperatures in which the filter can be operated continuously. $-10^{\circ}\text{C} \sim +60^{\circ}\text{C}$

Storage temperature rang

Storage temperature rang is the rang of ambient temperatures at which the filter can be stored without damage.

Conditions are as specified elsewhere in these specifications. $-40^{\circ}\text{C} \sim +70^{\circ}\text{C}$

Reference temperature $+25^{\circ}\text{C}$

2.1 Maximum Rating

DC voltage	VDC	12	V	Between any terminals
AC voltage	Vpp	10	V	Between any terminals

2.2 Electrical Characteristics

Characteristics in B/G,L/L' mode (switching input pin 2 connected to ground pin 3)

Source impedance $Z_s=50\ \Omega$

Load impedance $Z_L=2k\ \Omega //3pF$ $T_A=25^{\circ}\text{C}$

Item	Freq	min	typ	max	
Insertion attenuation Reference level	37.40MHz	14.5	16.5	18.5	dB
Relative attenuation	38.90MHz	4.5	6.0	7.5	dB
	33.90MHz	-	7.9	-	dB
	34.47MHz	-1.0	0.5	2.0	dB
	33.40MHz	28.0	40.0	-	dB
	33.05MHz	-	36.0	-	dB
	30.90MHz	42.0	55.0	-	dB
	31.90MHz	42.0	56.0	-	dB
	32.40MHz	42.0	54.0	-	dB
	40.15MHz	35.0	47.0	-	dB
	40.40MHz	40.0	50.0	-	dB
41.40MHz	40.0	50.0	-	dB	
Sidelobe	25.00~31.90MHz	35.0	44.0		dB
	40.40~45.00MHz	35.0	41.0		dB
Reflected wave signal suppression 1.2 us ... 6.0 us after main pulse (test pulse 250 ns , carrier frequency 37.40 MHz)		40.0	50.0		dB
Feedthrough signal suppression 1.2 us ... 6.0 us after main pulse (test pulse 250 ns , carrier frequency 37.40 MHz)		42.0	52.0		dB
Temperature coefficient			-72		ppm/k

Characteristics in M/N mode (switching input pin 2 connected to input pin 1)

Source impedance $Z_S=50\ \Omega$
 Load impedance $Z_L=2k\ \Omega //3pF$ $T_A=25^\circ C$

Item	Freq	min	Typ	max	
Insertion attenuation Reference level	37.40MHz	14.5	16.5	18.5	dB
Relative attenuation	38.90MHz	4.9	6.4	7.9	dB
	35.32MHz	1.1	2.6	4.1	dB
	34.40MHz	22.0	35.0	-	dB
	32.90MHz	35.0	42.0	-	dB
	40.40MHz	40.0	47.0	-	dB
Sidelobe	25.00~32.90MHz	33.0	41.0		dB
	39.50~45.00MHz	30.0	37.0		dB
Reflected wave signal suppression 1.2 us ... 6.0 us after main pulse (test pulse 250 ns , carrier frequency 37.40 MHz)		40.0	50.0		dB
Feedthrough signal suppression 1.2 us ... 6.0 us after main pulse (test pulse 250 ns , carrier frequency 37.40 MHz)		-	48.0		dB
Temperature coefficient		-72			ppm/k

2.3 Environmental Performance Characteristics

Item Test condition	Allowable change of absolute Level at center frequency(dB)
High temperature test 70°C 1000H	< 1.0
Low temperature test -40°C 1000H	< 1.0
Humidity test 40°C 90-95% 1000H	< 1.0
Thermal shock -20°C==25°C==80°C 20 cycle 30M 10M 30M	< 1.0
Solder temperature test Sold temp.260°C for 10 sec.	< 1.0
Soldering Immerse the pins melt solder at 260°C+5/-0°C for 5 sec.	More then 95% of total area of the pins should be covered with solder

2.4 Mechanical Test

Item Test condition	Allowable change of absolute Level at center frequency(dB)
Vibration test	<1.0

600-3300rpm amplitude 1.5mm 3 directions 2 H each	
Drop test On maple plate from 1 m high 3 times	<1.0
Lead pull test Pull with 1 kg force for 30 seconds	<1.0
Lead bend test 90° bending with 500g weigh 2 times	<1.0

2.5 Voltage Discharge Test

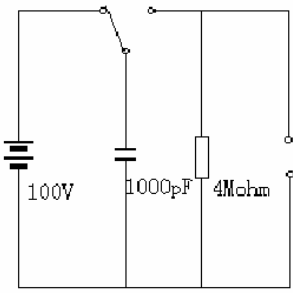
Item Test condition	Allowable change of absolute Level at center frequency(dB)
Surge test Between any two electrode 	<1.0

3.6 Frequency response

Frequency response in B/G,L/L' mode

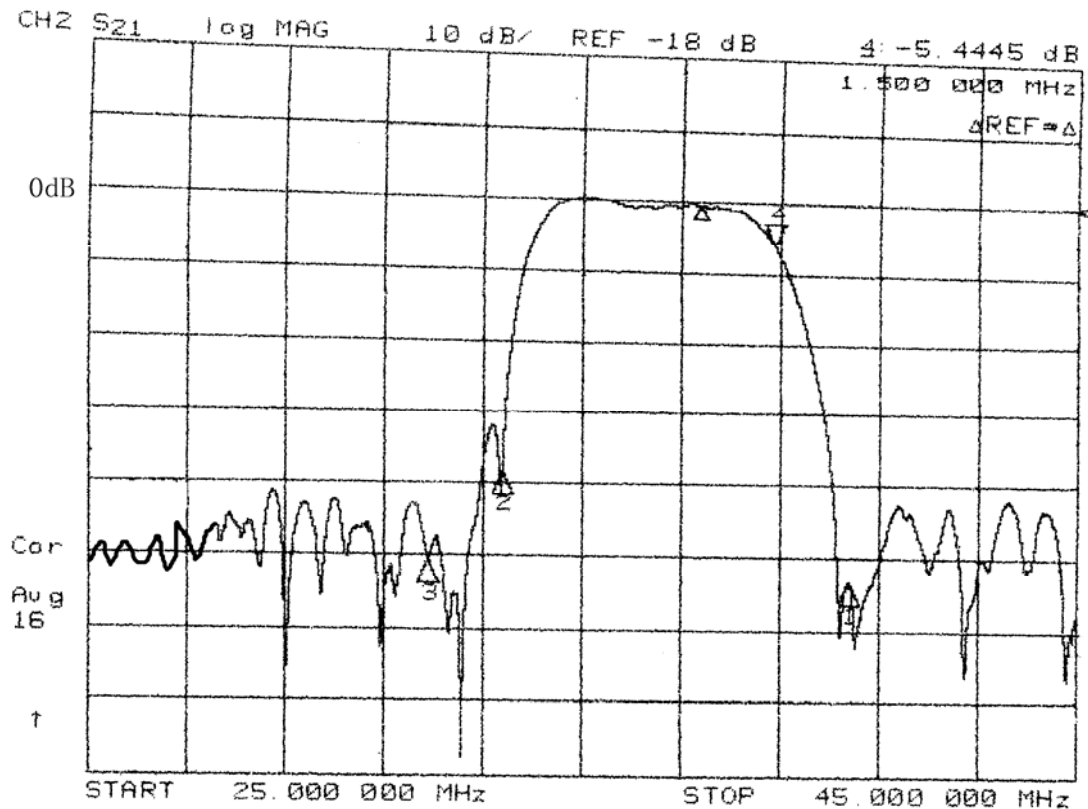

CH1 S21 log MAG 1 dB/ REF -19 dB 2: -.0099 dB
 CH2 S21 delay 30 ns/ REF 1.296 μ s 2: -389.26 ps

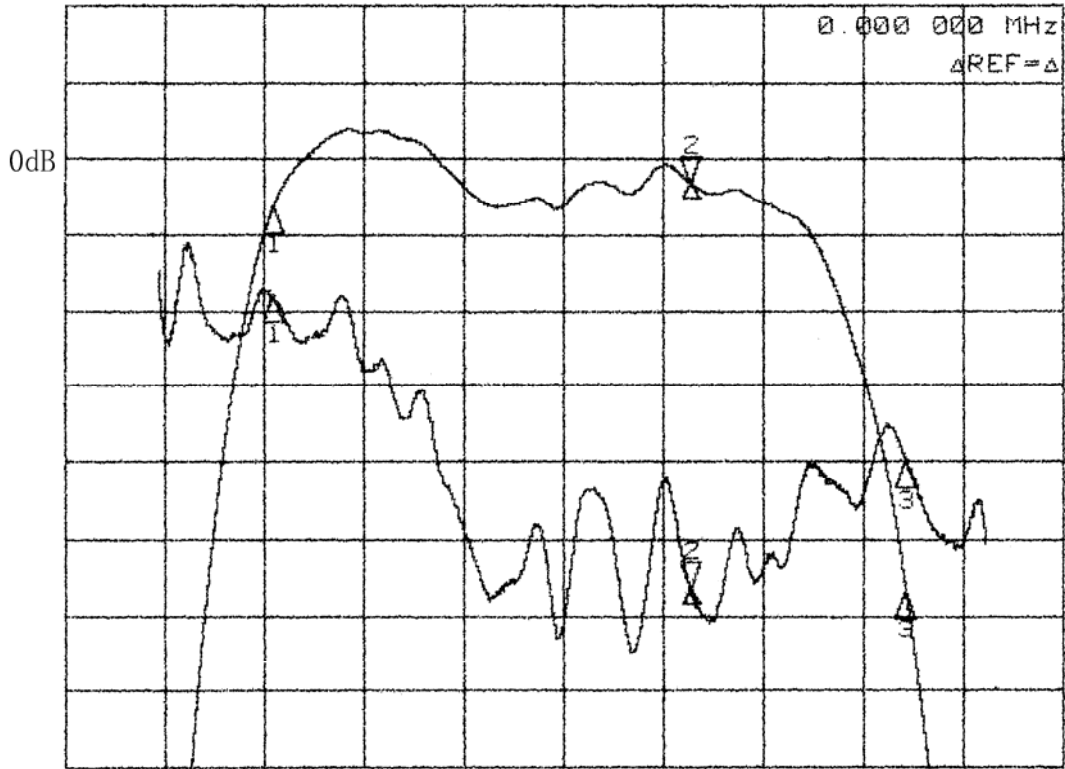

START 33.000 000 MHz STOP 40.000 000 MHz

CH2 S21 log MAG 10 dB/ REF -25.4 dB

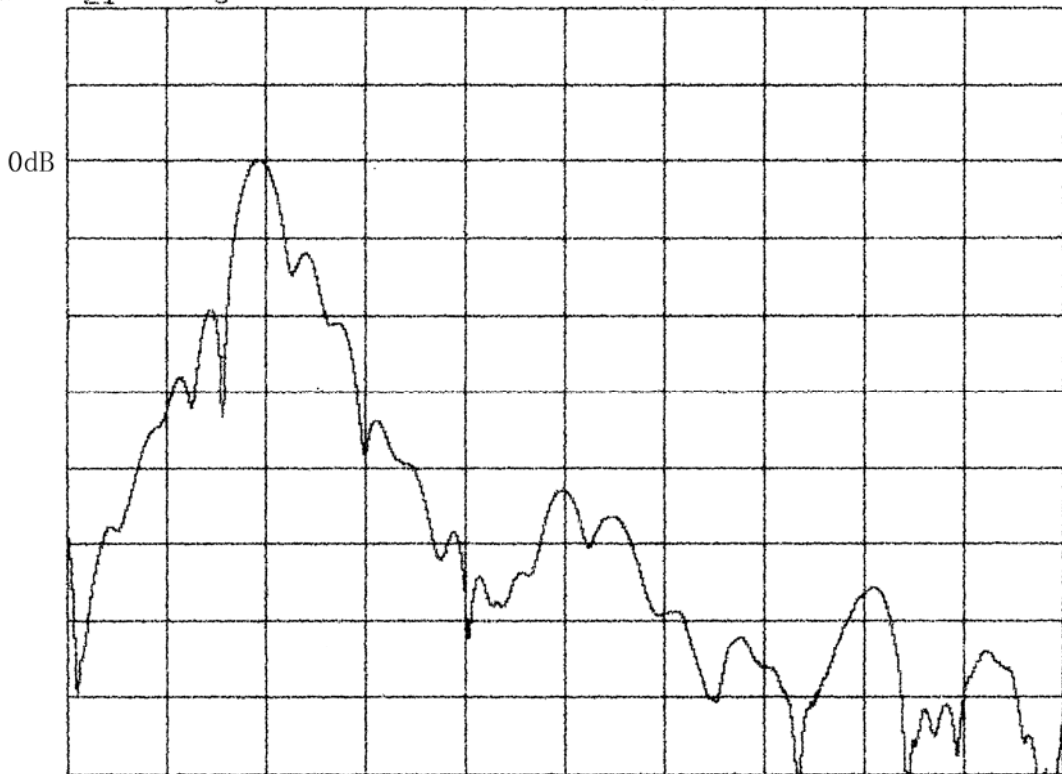

CH2 START 0 s STOP 6 μ s

Frequency response in B/G,L/L' mode

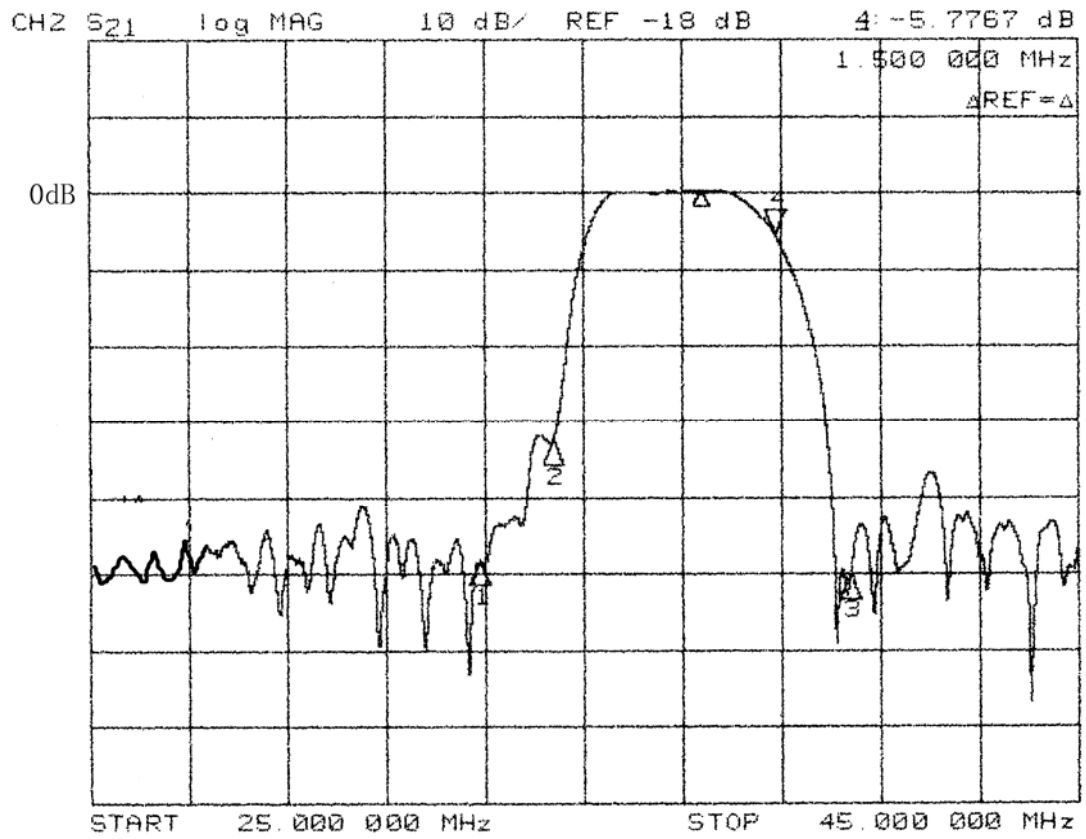

CH1 S21 log MAG 1 dB/ REF -17.68 dB 2: .0054 dB
CH2 S21 delay 30 ns/ REF 1.254 μ s 2 -140.06 ps

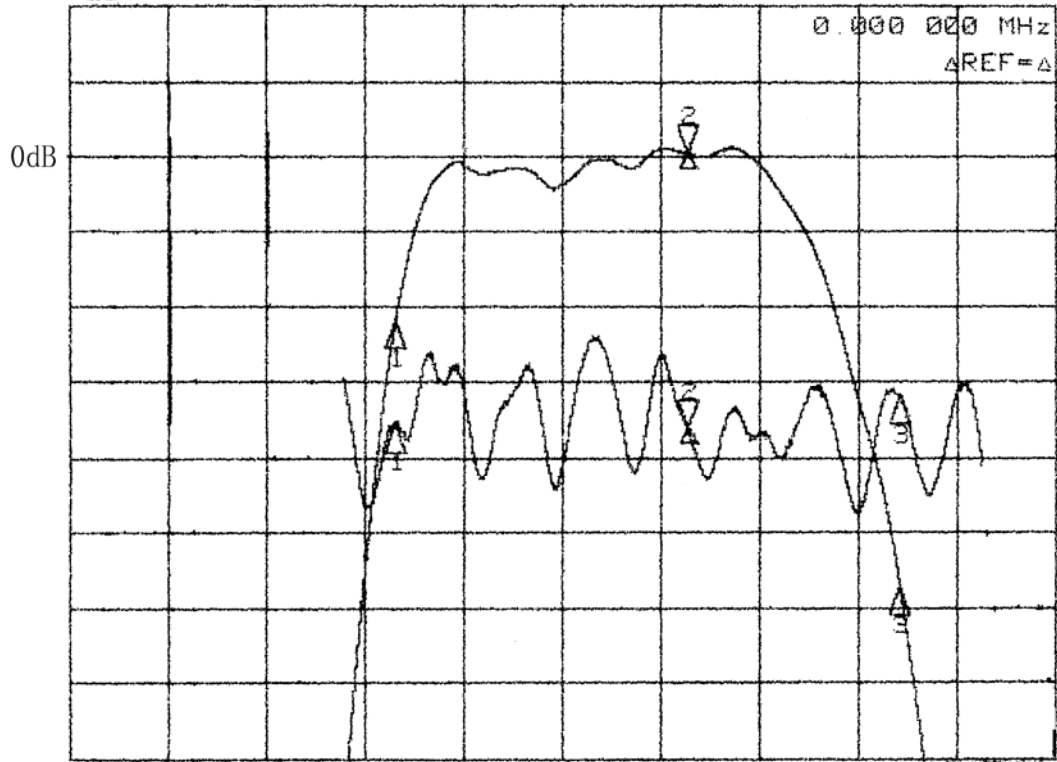

START 33.000 000 MHz STOP 40.000 000 MHz

CH2 S21 log MAG 10 dB/ REF -26.62 dB

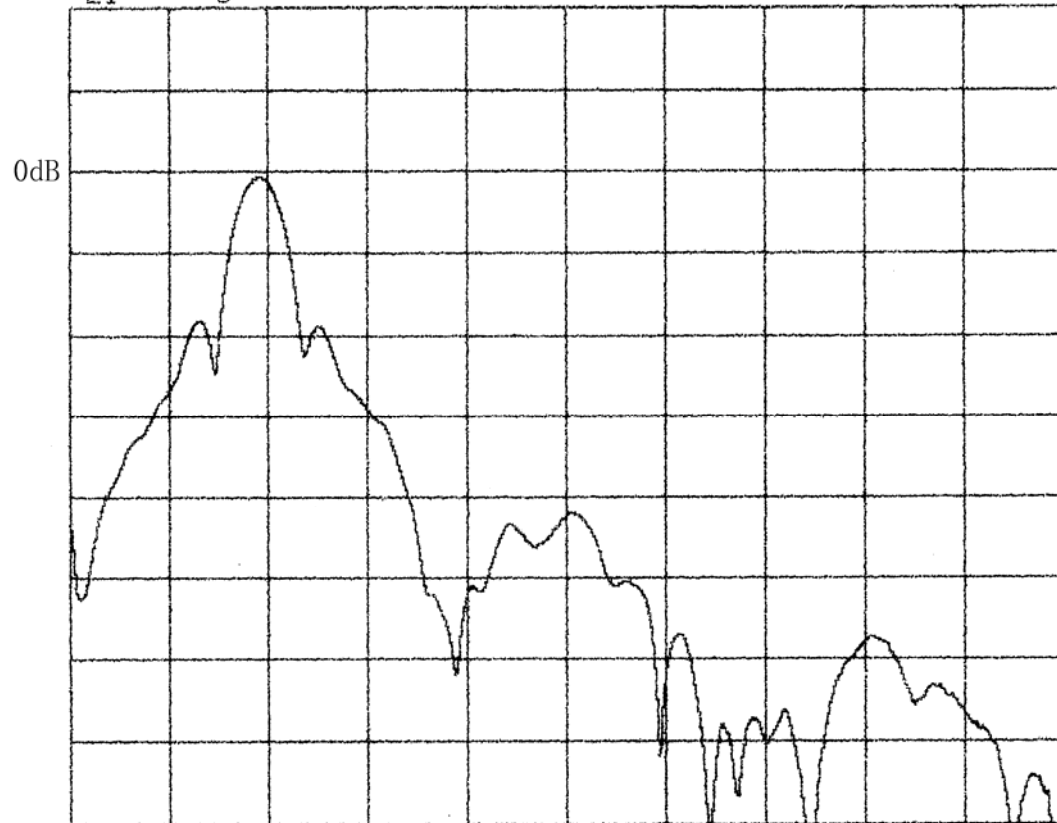

CH2 CENTER 3 μ s

SPAN 6 μ s